

## *“The beauty of a product lies in its details”*

*The beautiful things in life make us happy and give us a positive vibe. So create a special place in your garden, surrounded by carefully chosen impressions, with furniture that gives you great comfort.*

*Traditional Teak has selected the teak wood used for our furniture with great care. Endless hours of imagination, design aesthetics with great love for craftsmanship and the beauty of nature, go into the making of every item.*

*The trained eye recognizes the precise processing of solid Teak, recording their aesthetic attributes for years to come, creating “Antiques for the future”.*

*The lively grain of the wood surface makes each piece of furniture unique; the wood feels alive, enhances the atmosphere, has a soothing effect on people and catches the eye.*

*High environmental standards and sustainable forestry are just as much a criterion as the quality of the wood. That is why we only process Teak with an FSC quality mark or from state-controlled forestry.*

*Timeless furniture, made for the outdoors, designed by Traditional Teak.*

*Chris Bachmann  
Founder of Traditional Teak*



Grace	10	Lilly	108
Kate	14	Sisi	109
Sarah	36	Soraya	110
Carlos	38	Alexandra	112
Luna	40	Theodora	114
Baron	46	Beatrice	116
Mosaic-teak	48	Anna	118
Moritz	50	William	120
Diana	52	Manon	122
Diana mosaic	54	Cushions	124
Sienna	56	Maintenance	130
Sienna mosaic	58	Details	132
Maxima lounge	60	Covers	154
Maxima	68		
Noah	78		
Victoria	82		
Noor	94		
Alexia	96		
Floris	102		
Leah	104		
Wilhelmina	106		

# WHY TRADITIONAL TEAK

Our most important principles, since the day we started, is to make timeless, exclusive garden furniture of the highest quality. But despite our competitive prices we make no concessions in terms of comfort, durability and sustainability. A successful blend of precision and functionality is what Traditional Teak is all about. This makes our furniture a great investment for the future.

## Material



- Teak heeft een natuurlijke warme uitstraling, is weerbestendig, sfeervol, duurzaam, onderhoudsvriendelijk en puur.
- Roestvrijstalen verbindingdelen, zoals bouten en moeren zijn bestand tegen de hoogste belasting en vormen een optimaal samenspel met het teakhout.
- Traditional Teak maakt uitsluitend gebruik van hoogwaardige materialen zoals geweven kunststof b.v. Batyline® en voor de kussen collectie alleen de allerbeste stoffen van Sunbrella®



- Teak has a warm appearance, is weatherproof, durable, low maintenance, pure and stylish.
- Connections are made of Stainless steel, like bolts and nuts and are resistant to the highest load, also beautiful in combination with Teak.
- We only use the best material available, like the Batyline® used for the woven materials and for the cushions only the best like Sunbrella® fabric.



- Teak ein Rohstoff mit Seele, hat eine natürliche warme Ausstrahlung, ist Wetterbeständig, Attraktiv, Langlebig, leicht zu Reinigen und pur.
- Edelstahl-Verbindungen für die höchste Belastung und der optimalen Interaktion mit Teakholz.
- Traditional Teak verwendet nur hochwertige Materialien wie gewebte Kunststoffe z.B. Batyline® und für die Kissen Kollektion nur die besten Stoffe von Sunbrella®.

## Quality



- Volgens de oude traditie worden de latten met de hand uitgezocht en geselecteerd.
- Solide weerbestendige pen-en-gat verbindingen verankert met houten deuvels.
- Persoonlijke kwaliteitscontrole ter plaatse, gedurende de productie met oog voor detail.

- According to old traditions the slats are hand picked and selected.
- Solid weatherproof mortise-and-tenon joint connections anchored with wooden dowels.
- We supervise the quality on sight during production in person, with attention for details.

- Nach alter Tradition werden die Latten handverlesen und die Zapfen-Loch-Verbindungen mit Holzdübel fixiert.
- Persönliche Qualitätskontrolle an Ort und Stelle während der Produktion, mit Liebe zum Detail.

## Design



- Traditional Teak ontwerpt en produceert exclusief buitenmeubilair in eigen beheer die generaties lang meegaat.
- Zowel onze klassieke, maar ook onze hedendaagse designs zijn esthetisch en doordacht.
- Het assortiment wordt voortdurend zorgvuldig verder ontwikkeld.

- Traditional Teak designs and manufactures high quality garden furniture, which will last for generations.
- Designs both classic and modern are gorgeous and well considered.
- We're constantly developing/ renewing our collection.

- Traditional Teak entwickelt und produziert exklusive Outdoor-Möbel im eigenen Hause die Generationen überdauern.
- Designe im klassischen Stil aber auch mit moderner Formensprache.
- Das Sortiment wird kontinuierlich und sorgsam weiterentwickelt.

## Durable



- Traditional Teak werkt uitsluitend met gecertificeerde partners en op basis van Fair Trade.
- Het teakhout wordt geoogst volgens de normen op het gebied van verantwoord bosbeheer.
- Milieuvriendelijk fabricageproces gebaseerd op duurzame, hernieuwbare hulpbronnen met respect voor de mensen en milieu.

- We personally guarantee the craftsmanship and the high quality of all our furniture and work together with certified partners based on Fair-trade agreements.
- The teakwood used is harvested according to the standards in terms of responsible forest management.
- Teak is one of the most wonderful raw and renewable resources of this world. We treat these raw materials of the earth with respect and responsibility, towards the environment and people.

- Umweltfreundliche Herstellungsverfahren mit der Grundlage nachhaltiger, erneuerbarer Ressourcen.
- Traditional Teak recherchieren persönlich vor Ort, garantieren die ofengetrocknete Qualität des alten Plantagenholzes und richten sich nach den 2013 erlassenen EU-Importrichtlinien des Aktionsplans FLEGT (Forrest Law Enforcement Governance and Trade).



Grace table 191 x 100 cm, Grace stacking chair with CCM cushion



- Uniek ontwerp, rechte lijnen, massief
- A Unique design, straight lines, massive
- Einzigartiges Design, geradlinig, stabil

sizes Grace table :  
 191 x 100 cm  
 240 x 100 cm  
 300 x 100 cm



# G RACE

stacking chair



- Een uniek lijnenspel en zeer comfortabel
- A Unique pattern and very comfortable
- Einzigartiges Linienspiel und sehr komfortabel

Cushion code: CCM



Grace stacking chair, Grace tabel 191 x 100 cm

# KATE

lazy lounge chair  
and footstool



Kate lazy lounge chair with footstool - taupe

Available colors:

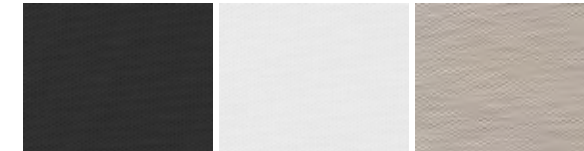

Black

White

Taupe

- De Kate Lazy lounge chair, gemaakt van een materiaalmix van slijtvast Textilene-doek en weerbestendig teakhout, overtuigt door zijn moderne uitstraling en hoogwaardige afwerking. De licht achterover hellende zitting en bijpassende footstool zorgen voor een aangenaam comfort.
- The combination of solid teakwood and strong Textilene fabric, give the Kate lazy lounge chair a modern, contemporary look.
- Der Kate Lazy lounge chair im Materialmix aus strapazierfähigem Textilene-Gewebe und witterungsbeständigem Teakholz überzeugt durch sein modernes Aussehen und hochwertige Verarbeitung.







Available colors:

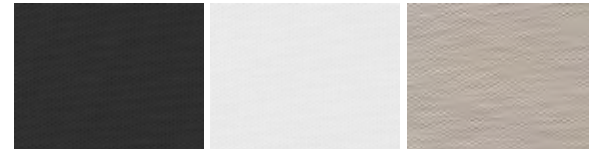

Black

White

Taupe

- De Kate bank, designed by Traditional Teak, heeft een stevig teakhouten frame gecombineerd met een Textilene zit en rug gedeelte. De bank combineert stijl en functionaliteit, is comfortabel en licht van gewicht.
- The Kate bench, designed by Traditional Teak, is a bench with a solid teakwood frame combined with a Textilene seat and back. The Kate bench combines style and functionality, is very comfortable and lightweight.
- Die von Traditional Teak konzipierte Bank Kate, ist eine Gartenbank mit stabilem Teakholzrahmen, kombiniert mit Sitz- und Rückenteil aus Textilene. Diese Bank vereint Stil und Funktionalität, ist bequem und sehr Leicht im Gewicht.

size Kate bench: 150 cm



Kate bench 150 cm - black

# KATE deckchair



Kate deckchair - black



wheels are optional

Available colors:

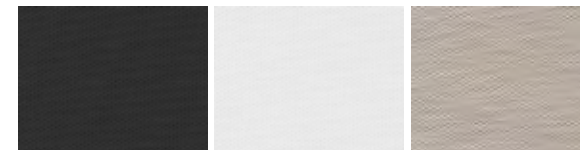

Black

White

Taupe

- Een uiterst comfortabele deckchair met een uitstekend zit- en ligcomfort ook zonder kussen. De stoel is licht in gewicht, en verstelbaar in 4 verschillende standen. De Kate deckchair is ook leverbaar met wielen.
- The Kate deckchair is the most ideal sunbed, it is very comfortable, due to the adjustable backrest in multiple positions. The Kate deckchair is also available with wheels.
- Der Kate Deckchair ist ein äußerst bequemer Liegestuhl mit einem ausgezeichnetem Sitz- und Liegekomfort (auch ohne Kissen). Der Stuhl ist leicht und in 4 verschiedenen Positionen verstelbar. Der Stuhl ist auch mit Räder verfügbar.

Cushion code: CDM185 - CD185 - CDE185 - DCD185





**K**ATE  
director chair

Kate director chair - taupe, Alexia folding table 70 x 70 cm



Available colors:

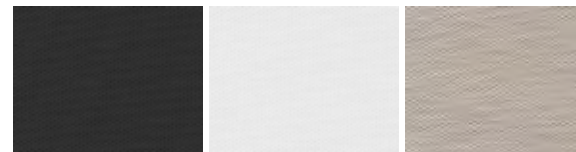

Black

White

Taupe

- De Kate director chair is een moderne interpretatie van de klassieke regisseur stoel, de stoel neemt in opgevouwen toestand minimale ruimte in.
- The Kate director chair is a modified version of the classic director's chair. The "quick-dry" Textilene seat and backrest provides incomparable comfort without cushions.
- Der Kate Director chair ist eine moderne Interpretation des klassischen Regiestuhl. Im zusammengeklappten Zustand nimmt er nur minimal Platz ein.

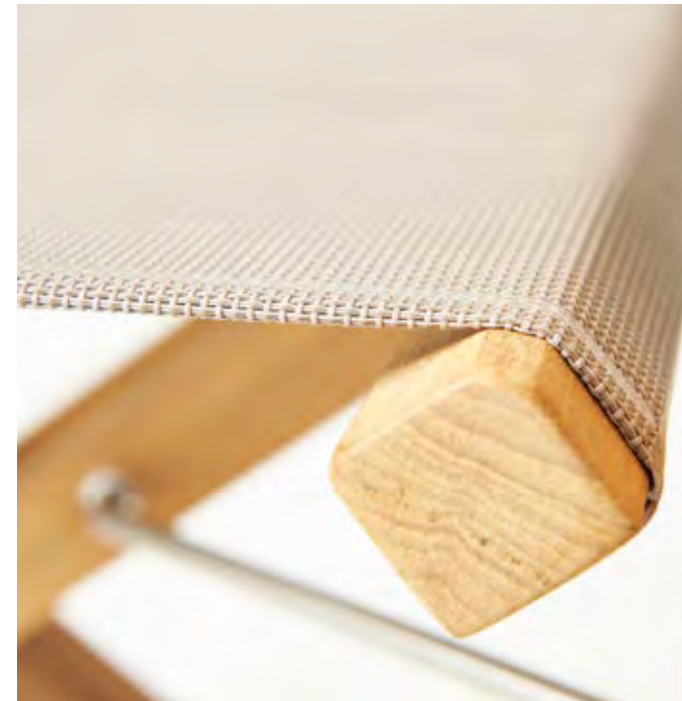



Available colors:

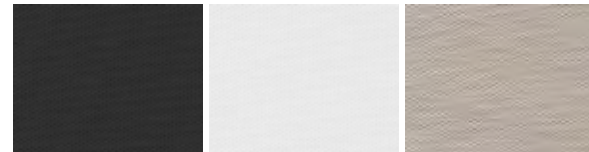

Black

White

Taupe

- Deze makkelijk te transporteren, licht gewicht relax chair is verstelbaar in 4 comfortabele zitposities. De Kate relax chair word geleverd met verstelbaar nekkussen.
- This lightweight and durable chair folds up flat for true portability. The chair is adjustable in 4 different positions for ultimate relaxation. The chair comes with an adjustable neck cushion.
- Für den ganz besonderen Relax Moment, am Strand oder einfach im Garten. Leicht im Gewicht in 4 Stufen einstellbar, einfach zusammen zu falten und mit zu nehmen. Der Relax chair hat ein verstellbares Nackenkissen.



# KATE

recliner & footstool



Kate recliner - white, Soraya table 200 x 100 cm



Available colors:

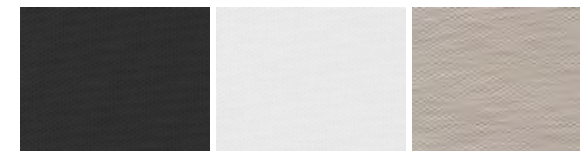

Black

White

Taupe

- De Kate recliner is soepel in te klappen, licht in gewicht en heeft een rug die in 7 standen te verstellen is. Met de bijpassende footstool heeft u nog meer zit comfort.
- The Kate recliner is an easy to fold, lightweight chair and has an adjustable back (7-positions) and the matching footstool provides even more sit comfort.
- Der Kate Recliner ist einfach einzuklappen, leicht im Gewicht und hat einen verstellbaren Rücken in 7 Stufen. Mit dem passenden Kate hocker haben Sie noch mehr Sitzkomfort.

Cushion code: CRM123 - CR123 - CRE123



# KATE

folding armchair



Available colors:

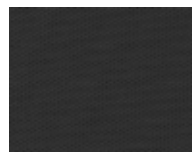

Black

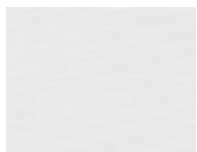

White



Taupe

- De Kate folding armchair is voorzien van een textilene zitting en rug, is volledig inklapbaar, blijft ingeklapt zelfstandig staan en is bovendien ruimte-besparend op te bergen.
- This Kate folding armchair has textilene slings, folds easaly by lifting the seat and when folded, the chair can stand on its own in an upright position.
- Der Kate folding armchair ist ausgestattet mit Textilene Sitz und Rücken was im einen Körpergerechten Komfort verleiht. Der Kate folding armchair beansprucht Zusammengeklappt nur wenig Platz.



Kate folding arm chair - taupe, Diana table 125 cm

# KATE

folding chair



Kate folding chair white, Manon table 35 cm



Available colors:

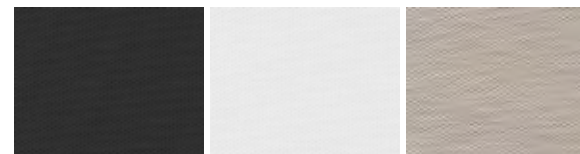

Black

White

Taupe

- RVS beslag, licht in gewicht en simpel op te vouwen, waardoor de stoel snel en gemakkelijk te vervoeren is.
- Stainless steel fittings and light weight ensure the chair is easy to fold and quickly and easy to transport.
- Beschläge aus Edelstahl und das leichte Gewicht sorgen dafür, dass Sie den Klapstuhl schnell und einfach zusammenklappen und transportieren können.





Available colors:

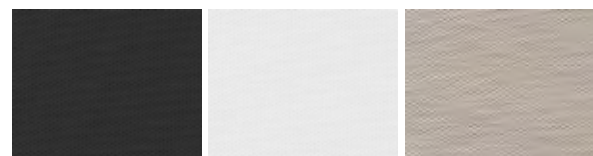

Black

White

Taupe

- De Kate stacking chair is licht in gewicht met een uitstekend zitcomfort, onderhoudsvriendelijk en ruimtebesparend op te bergen.
- The strong breathable mesh of the Kate stacking chair conforms to the human shape and allows air circulation at contact points. The Chairs can be stacked four high for convenient storage.
- Der Kate stacking chair ist sehr leicht und mit seiner breiten Sitzfläche und ergonomisch geformten Rückenlehne äußerst komfortabel. Der Kate stacking chair ist stapelbar.

**K**A**T**E  
stacking chair



Kate stacking chair - white, Noah table 243 x 91 cm



# KATE lounger



Kate Lounger - black with Kate neckrol - black



Available colors:

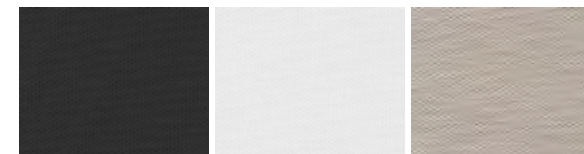

Black

White

Taupe

- De Kate lounger is in diverse standen verstelbaar en voorzien van wielen waardoor hij eenvoudig is te verplaatsen.
- The adjustable backrest of the Kate lounger provides full support in multiple positions, for a truly relaxing experience.
- Die verstellbare Rückenlehne von der Kate Liege macht das Sonnen auch in der Bauchlage möglich und dank der Räder aus Teak und Gummi lässt sich die Liege leicht durch den Garten bewegen.

Cushion code: CLM200 - CL200 - CLE200 - DCL200



# KATE

neckroll



Available colors:

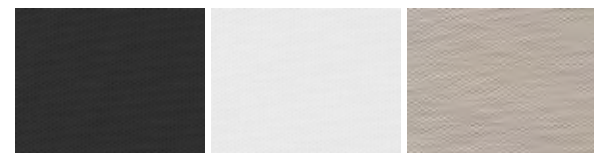

Black

White

Taupe

- Traditional Teak heeft een nekkussen ontwikkeld om het comfort van de Kate lounger, Kate deckchair en de Kate reciner te verhogen. Het halfronde nekkussen, is eenvoudig te monteren en door de klittenbandsluiting makkelijk in te stellen.
- Traditional Teak has developed a comfortable neckroll to increase the comfort for the Kate recliner, Kate lounger and the Kate deckchair.
- Um den Sitzkomfort der Kate Serie noch angenehmer zu gestalten bietet Traditional Teak ein Kopfkissen, das sich für den Kate-Hochlehner, Kate Deckchair und die Kate Liege eignet.



Kate lounger - black with Kate neckroll - black

# SARAH

BENCH



Sarah bench 185 cm



- De Sarah bank van Traditional Teak is een echte klassieker en wordt beschouwd als de typische Engelse tuinbank. De zitting, die licht naar achteren helt, zorgt voor een optimaal zitcomfort. De ruglatten gaan zonder overgang met een beproefde pen- en gatverbinding elegant over in de dwarsbalk.

**Cushion code:** CB150 - CBE150  
CB180 - CBE180

- The Sarah bench by Traditional Teak is a real classic design and considered a typical English garden bench. The backslats go (without transition), with a proven mortise and tenon joint elegantly over in the crossbar.

sizes Sarah bench: 155 cm - 185 cm

- Die klassische Gartenbank Sarah von Traditional Teak gilt als die typische englische Gartenbank. Gemacht aus hochwertigem Teakholz mit einem geradlinig gestaltetem Rückenelement. Die Leisten des Rückens gehen elegant und sanft mit altbewährten Zapfenverbindungen über in die Querstreben.



Carlos stacking chair, Floris table 213 x 91 cm

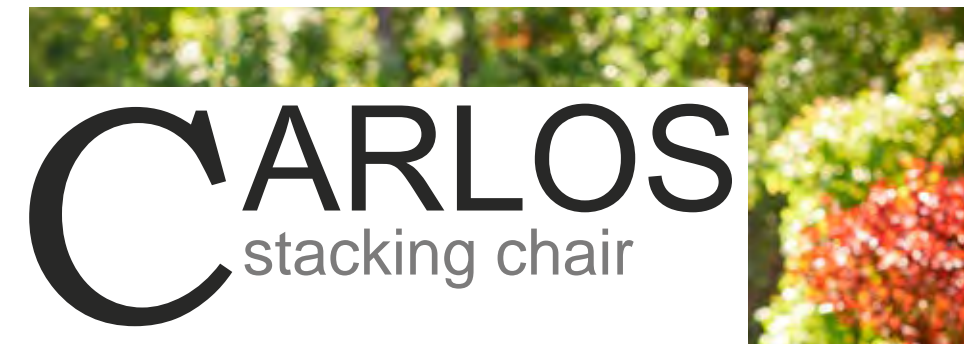

- Klassiek ontwerp, licht en bijzonder comfortabel.
- An unique classic design which due to subtly curved back for extra comfort, brings ergonomics to the garden.
- Sein schwungvolles Design, die leicht nach hinten geneigte Sitzfläche und die beiden Armlehnen ermöglichen ein sehr komfortables Sitzgefühl.

Cushion code: CCN



# LUNA

table/ side table



Luna side table: 50 x 50 cm

- Een klassiek design, modern vormgegeven. Kleinere bijzettafel variant 50 x 50 cm met teakhouten poten.
- A classic design with a modern touch. Also as side table (50 x 50 cm) with solid teak legs.
- Ein klassisches Design, modern gestaltet. Der Luna tisch ist Auch als kleiner Beistelltisch erhältlich (50 x 50 cm) ausgestattet mit soliden Tischbeinen aus Teakholz.

sizes Luna tables: 50 x 50 cm  
 90 x 90 cm  
 120 x 120 cm  
 217 x 90 cm

Legs available in:



aluminum anthracite

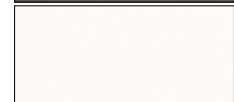

aluminum white

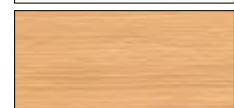

solid teakwood



Luna table 217 x 90 cm, Luna backless bench 90 and 202 cm, Luna stacking chair - white and taupe



Luna stacking chair - taupe, Luna table 120 x 120 cm



**LUNA**  
stacking chair



Available colors:

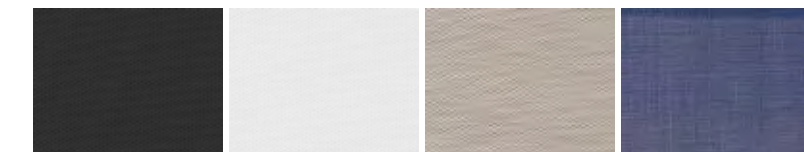

Black White Taupe Blue

- Uitermate lichte stapelstoel met een goed zitcomfort.
- Very light, durable, easy to clean and stackable chair.
- Äußerst leichter Stapelstuhl in Kombination mit robusten Materialien.



# LUNA

backless bench



- Elegante rugloze bank in 2 maten, V-vormige poten voor extra stabiliteit.
- Elegant backless bench in 2 sizes available, V-shaped legs for extra stability
- Elegante rückenloses Bank in 2 Größen, mit V-förmigen Beinen für extra Stabilität.

sizes Luna backless benches:     90 x 38 cm  
    202 x 38 cm

**Cushion code: CBL90 and CBL202**



# LUNA

lounger



- Verfijnd vakmanschap, puristisch design en met wielen om de lounger gemakkelijk te kunnen verplaatsen.
- The Luna lounger is impressing for it's craftsmanship design statement of simplicity and due to the wheels easy to move around.
- Veredelde Handwerkskunst, puristisch Design, handlich und leicht zu positionieren die Luna Sonnenliege mit Räder.

**Cushion code: CL200 - DCL200 - CLM200**

# BARON

bench



Baron bench 180 cm



- De Baron bank, een imposant en stijlvol voorbeeld van echt vakmanschap. De ultieme parkbank met een lengte van 180 cm
  - The Baron bench, an impressive and stylish example of real craftsmanship. The ultimate park bench is available in 180 cm
  - Die Baron Bank ist wahre Handwerkskunst mit zeitlosem Design, kombiniert mit Stil und Langlebigkeit. Ideal für die Aufstellung in großen Gärten oder an öffentlichen Einrichtungen. Verführbar in der Länge 180 cm
- size Baron bench: 180 cm





# MOSAIC TEAK

Traditional Teak **mosaic-teak**:

**mosaic-teak** is PUUR NATUUR  
**mosaic-teak** is MILIEU BEWUST  
**mosaic-teak** is ECHT HANDWERK  
**mosaic-teak** is GEMAAKT VAN A-KWALITEIT TEAK HOUT  
**mosaic-teak** is EXTREEM DUURZAAM  
**mosaic-teak** is TIJDLOOS DESIGN  
**mosaic-teak** - UITSTEKENDE PRIJS-KWALITEIT VERHOUDING

Traditional Teak **mosaic-teak**:

**mosaic-teak** is PUR NATURE  
**mosaic-teak** is ENVIRONMENT FRIENDLY  
**mosaic-teak** is CRAFTSMANSHIP  
**mosaic-teak** is EXQUISITE A-GRADE TEAKWOOD  
**mosaic-teak** is EXTREMELY DURABLE  
**mosaic-teak** is GREAT VALUE FOR YOUR MONEY  
**mosaic-teak** is A TIMELESS DESIGN

**mosaik-teak** von Traditional Teak:

**mosaic-teak** ist PUR NATUR  
**mosaic-teak** ist UMWELTBEWUSST  
**mosaic-teak** ist ECHTES HANDWERK  
**mosaic-teak** ist ERLESENES TEAK HOLZ  
**mosaic-teak** ist EXTREM LANGLEBIG  
**mosaic-teak** ist ZEITLOSES DESIGN  
**mosaic-teak** - AUSGEZEICHNETES PREIS - LEISTUNGS-VERHÄLTNIS

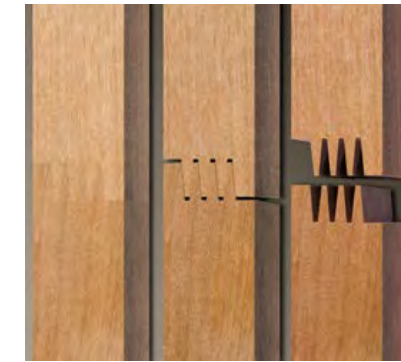

Zorgvuldig geselecteerde blokjes A-kwaliteit teak die op ambachtelijke wijze worden verwerkt waardoor het unieke silhouet van **mosaic-teak** wordt gecreëerd, dit met oog voor detail en liefde voor de natuur.

The furniture is manufactured using the best quality Teak wood and advanced machinery in sync with our well-known Traditional Teak high quality standards.

Verarbeitung mit einer einzigartigen Formgebung als Ergebnis, großer Liebe zum Handwerk und Freude an der Schönheit der Natur.

Een innovatieve combinatie uit geselecteerd teakhout, machinaal bewerkt en met hoogwaardige, watervaste en vullende polyurethaan houtlijm, dus supersterk, dit alles in overeenstemming met de reeds bekende kwaliteitsnormen van Traditional Teak.

Also, we make sure the offered furniture is checked on different quality parameters under the supervision of our quality controllers. These qualities, combined with its exceptionally beautiful colour and structure has given teakwood the name, 'the aristocrat of all wood'.

Eine innovative Kombination aus umweltbewussten, erlesenen Teakholz, maschinell bearbeitet und mit Qualitäts-Leim für den Yacht- und Schiffbau verklebt, alles in Übereinstimmung mit unseren bekannten Qualitätsstandards.

Wij zijn ervan overtuigd dat goed doordachte, met respect voor mens en natuur, geproduceerde producten een lang leven mooi zijn in uw tuin of op uw terras.

**Mosaic-teak** furniture is an environmentally friendly option, which will last a lifetime and often remains in families for generations.

Wir sind der Überzeugung dass gut konzipierte, nachhaltige Produkte ein langlebiges Outdoor-Möbel garantieren. Bewusst Denken & Handeln für Mensch und die Umwelt.

A successful blend of precision, functionality and quality is what makes our furniture a great investment for the future. Ausgewähltes Teak Holz in meisterlicher



Moritz mosaic table 180 x 91 cm, Moritz mosaic backless bench 168 cm

# MORITZ mosaic

table and backless bench

- De Moritz tafel en backless bench zijn gemaakt uit **mosaic-teak**, A-kwaliteit teak met een uniek patroon.
- The Moritz table and backless bench are made of eco friendly **mosaic-teak**, with its unique Mosaic-pattern.
- Der Moritz-Tisch und die Rückenlose Bank ist gefertigt aus mosaic-teak, in liebevoller Handarbeit zusammengefügte massive Teakholz Blöcke werden zu einer einzigartigen Mosaik Silhouette verbunden.

size Moritz **mosaic** table: 180 x 91 cm

size Moritz **mosaic** backless bench: 168 x 34 cm



# DIANA

round table



Kate folding arm - taupe, Diana table Ø 125 cm



- Moderne ronde tafel, verkrijgbaar met tafelpoten in massief teakhout, aluminium antraciet en aluminium wit.
- Modern round table is available with legs in solid teakwood, aluminum anthracite or aluminum white.
- Moderner runder Tisch, erhältlich mit Tischbeinen in den Materialien; Teakholz, Aluminium Anthrazit und Aluminium Weiß

sizes Diana table: Ø 95 cm  
 Ø 125 cm  
 Ø 145 cm

Legs available in:



# DIANA mosaic

round table / coffee table



Legs available in:



- Diana **mosaic tafel** uit A-kwaliteit teakhout, ambachtelijk verwerkt, milieubewust. Verkrijgbaar in 3 verschillende maten. Diana **mosaic side-** of coffee table uitvoering, in 2 verschillende maten en hoogtes, met massief teakhouten poten.
- **Diana mosaic made from** A-quality teakwood, environment friendly. Available in 3 different sizes. Also available Diana **mosaic side-or** coffee table in 2 sizes with solid teak legs.
- Diana **mosaic** Tisch gemacht aus A-Qualität Teakholz, handgefertigt, umweltbewusst. Tischbeine sind erhältlich in; Massives Teakholz, Aluminium Anthrazit und Aluminium Weiß. Auch verfügbar als Diana **mosaic side-** oder coffee table.

sizes Diana **mosaic-teak** table:    Ø 95 cm  
     Ø 125 cm  
     Ø 145 cm



**Diana mosaic side / coffee table**  
 Ø 50 en Ø 80 cm (hight 36 and 44,5 cm)



Diana mosaic table 125 cm, Kate recliners - white



Sienna beachchair with SBC cushion

# SIENNA

beachchair & footstool



- De Sienna beachchair met elegante rondingen die extra comfort geven. Het speciaal ontworpen kussen van Sunbrella® stof is in diverse kleuren beschikbaar.
- Extremely comfortable ergonomic seat through the curved roundings. There is a tailor made cushion available in Sunbrella® fabrics
- Der elegante Schwung des Möbels sorgt für den besonderen Komfort. Die zugehörigen Polster, wahlweise in verschiedenen Sunbrella® polster Designs verfügbar.

Cushion code: SBC

# SIENNA mosaic

beachchair & footstool



- De populaire Sienna beachchair is er ook in een **mosaic-teak** uitvoering. Milieubewust, recycled en tijdloos design. Het speciaal ontworpen kussen van Sunbrella® stof is in diverse kleuren beschikbaar.
- The popular Sienna beachchair also available in a **mosaic-teak**. Environmentally, sustainable and timeless design. There is a tailor made cushion available in Sunbrella® fabrics
- Der beliebte Sienna beachchair jetzt auch in einer **mosaic-teak** Version erhältlich. Umweltbewusst, Langlebigkeit und "ein ausgezeichnetes Preis-Leistungsverhältnis". Die zugehörigen Polster, wahlweise in verschiedenen Sunbrella® polster Designs verfügbar.

Cushion code: SBC



Sienna beachchair and footstool

# MAXIMA-LOUNGE

COLLECTION



Een bijzondere doch eenvoudige vorm, het beste kwaliteit teakhout, de perfecte afwerking en de individuele combinatiemogelijkheden geven u met de Maxima lounge serie de vrije hand bij het inrichten van uw tuin, terras of balkon. Van modulaire hoekbank tot loungeset met driezitsbank en stoelen, het is allemaal mogelijk! De lounge serie van Traditionele Teak wordt geleverd met Sunbrella® kussens. (vraag naar de mogelijkheden bij uw dealer)

This Maxima lounge program with its simple forms, the high-end quality of teak wood, the perfect finish and the numerous possibilities to combine, will give you the freedom you need decorating your own garden, terras or balcony. We realised an extra high seating comfort because of the built-in Batyline seat frame. The lounge series of Traditional Teak comes with Sunbrella® cushions (ask your local dealer for the possibilites)

Die Innovative Lounge-Gruppe Maxima, mit der geradlinigen Formensprache ein hochwertiges Teakholzmöbel, die perfekte Verarbeitung und die individuelle Kombinationsmöglichkeiten gibt ihnen völlig freie Hand in der Gestaltung ihres Gartens, Terrasse oder Balkon. Sie genießen extra hohen Sitzkomfort durch den eingebauten Batyline Rahmen im Sitzteil.

Die Lounge-Gruppe von Traditional Teak wird mit Sunbrella® Kissen geliefert (Fragen Sie Ihren Händler nach den möglichkeiten).



# MAXIMA lounge



Maxima lounge: 3 seater and hocker



Maxima lounge: chair with arm and hocker

- Als Solitair of in combinatie met andere elementen, uw zit- en leefomgeving is eenvoudig te veranderen door de opstelling aan te passen of een extra element toe te voegen.
- as Solitair or together with other modules to design your own lounge or combine modules to create a large sofa to suit your own needs and fit for any space.
- Als einzelstück oder Sie können ganz einfach Ihren Sitzplatz oder Umgebung ändern, indem Sie die Aufstellung anpassen oder ein zusätzliches Element hinzufügen.



Maxima lounge: 3-seater



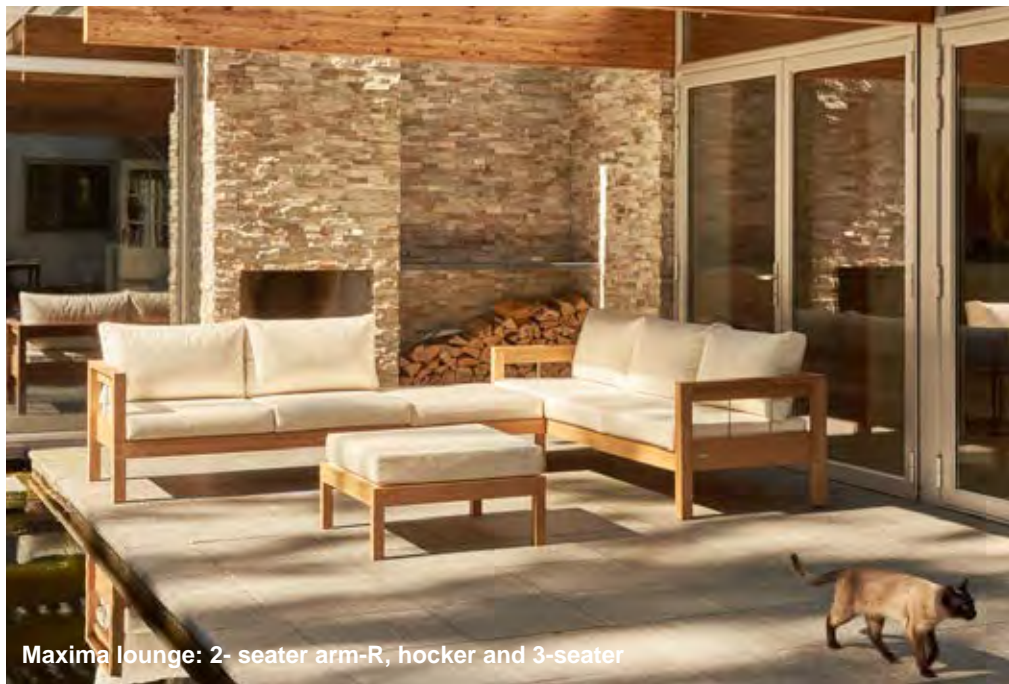

Maxima lounge: 2- seater arm-R, hocker and 3-seater



# M AXIMA

lounge

Maxima lounge: 2- seater arm-L, chair w/o arm, 2-seater arm-L and hocker



Maxima lounge: 2- seater arm-L, chair w/o arm,  
2-seater arm-L and hocker



Maxima lounge: 3- seater, chair w/o arm and 2-seater arm-L

# MAXIMA lounge - sets

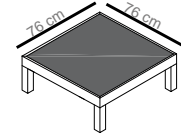

MAXIMA LOUNGE HOCKER

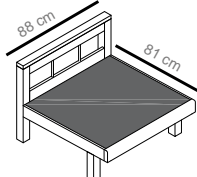

MAXIMA LOUNGE CHAIR W/O ARM

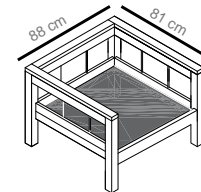

MAXIMA LOUNGE CHAIR WITH ARM

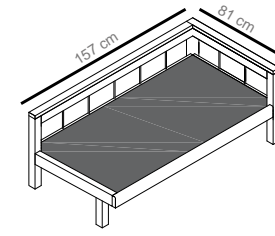

MAXIMA LOUNGE 2 SEATER ARM-L

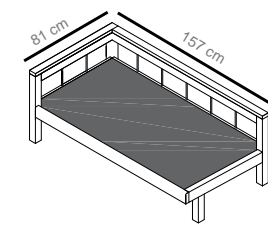

MAXIMA LOUNGE 2 SEATER ARM-R

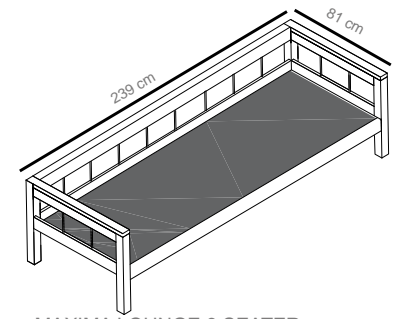

MAXIMA LOUNGE 3 SEATER

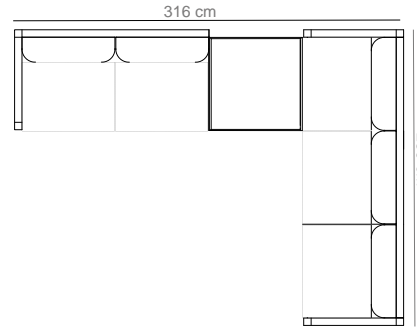

module: 2- seater arm-R, hocker, 3-seater

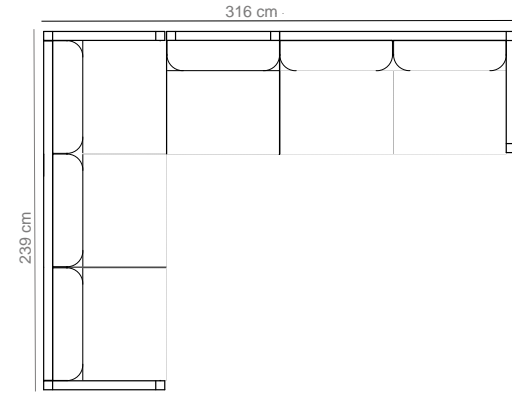

module: 2- seater arm-L, chair w/o arm, 3-seater

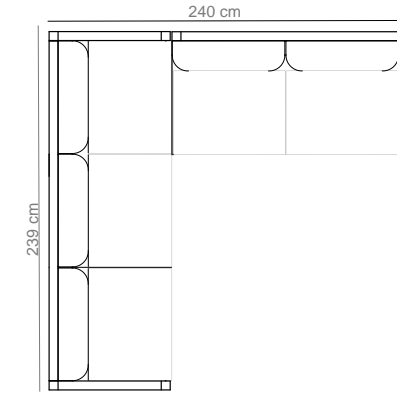

module: 2- seater arm-L, 3-seater

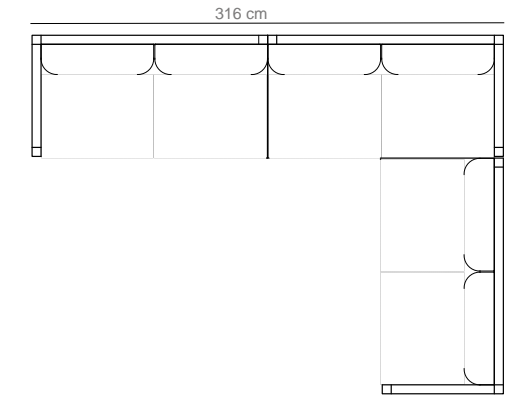

module: 2- seater arm-R, 2- seater arm-L, 2- seater arm-L

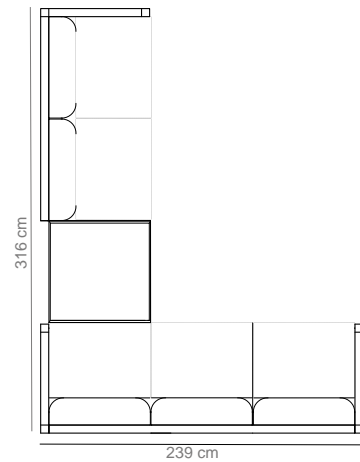

module: 2- seater arm-L, hocker, 3-seater

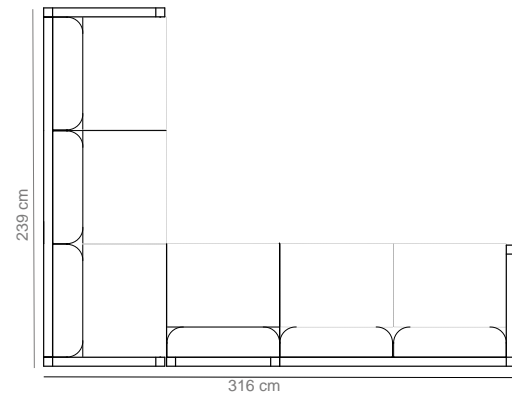

module: 2- seater arm-R, chair w/o arm, 3-seater

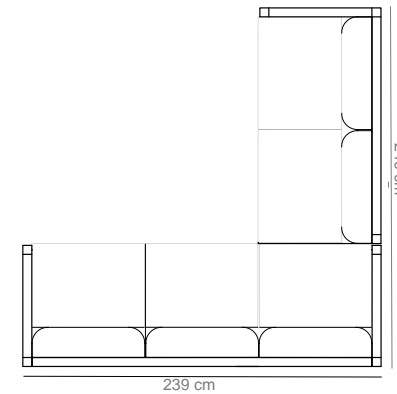

module: 2- seater arm-R, 3-seater

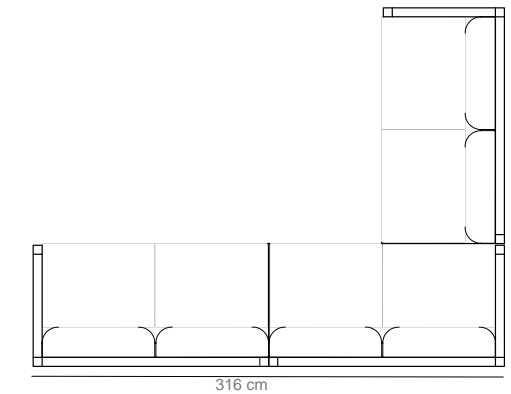

module: 2- seater arm-L, 2- seater arm-R, 2- seater arm-R

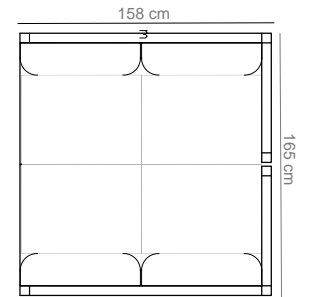

module: 2- seater arm-R, 2- seater arm-L,

# M AXIMA

stacking chair



Maxima stacking chair, Maxima table 103 x 103 cm



- Strakke lijnen, rechte hoeken en roestvrijstaal karakteriseren de Maxima stacking chair.
- Clean lines, right angles and stainless steel characterize the Maxima stacking chair.
- Gerade Linien, rechte Winkel und Edelstahl akzentieren den Maxima stacking chair.

Cushion code: CCM

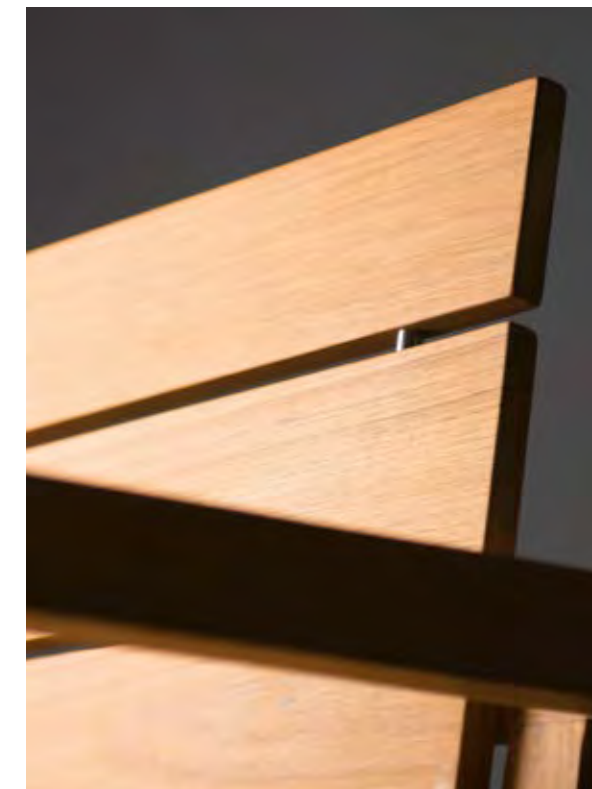

# MAXIMA bench

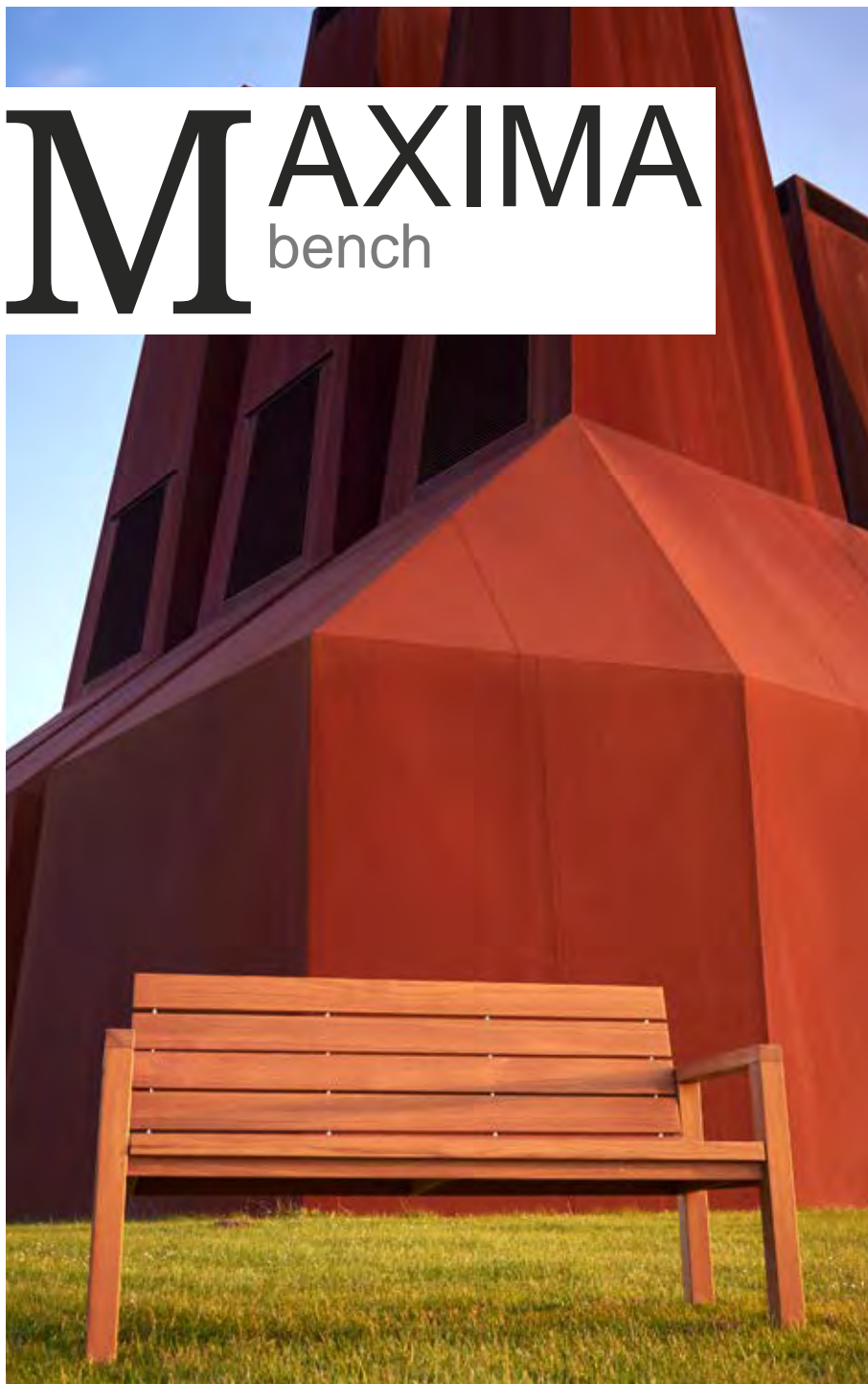

- Van een traditionele park- of tuinbank naar een strak, modern design. De Maxima bank is leverbaar met en zonder armleuningen.
- Transformation from a traditional park or garden bench to a contemporary design. The bench is available with and without armrests.
- Interpretation der alt bekannten Park oder Gartenbank, von Traditioneller Ausführung nach ein moderner Form. Die Bank ist lieferbar mit und ohne Armlehnen.

Bench / Cushion code:

155 cm / **CM155 - ACM155 - 2ACM155**

180 cm / **CM180 - ACM180 - 2ACM180**

215 cm / **CM215 - ACM215 - 2ACM215**



2xMaxima bench (without arms) 155 cm



Maxima bench 155 cm



- De Maxima corner bench past op alle afmetingen van de Maxima bank, (met- of zonder armleuning) waardoor u een perfecte hoekbank kunt creëren.
- The Maxima corner bench fits all sizes Maxima benches (with or without arms), allow you to make numerous variations.
- Die Maxima corner bench passt auf alle Längen von den Maxima Bänken (mit oder ohne armlehnen), so dass verschiedene Kombinationen machbar sind.

**Cushion code:**

**ACM155 - 2ACM155**

**ACM180 - 2ACM180**

**ACM215 - 2ACM215**

**CMCB**

# M AXIMA

corner bench



Maxima bench 180 cm, Maxima bench 155 cm and Maxima corner bench

# MAXIMA

table



Maxima table 240 x 103, Maxima backless bench 180 cm and Maxima stacking chair



- De Maxima table is een echte highlight op uw terras. De masief teakhouten tafel is in drie maten verkrijgbaar en voorzien van vier in hoogte verstelbare beschermdoppen.
- The Maxima table is available in three different sizes and is equipped with four in height adjustable gliders. The Maxima table looks beautiful everywhere.
- Der Massivholz Tisch Maxima ist ein echtes Highlight auf ihrer Terrasse, lieferbar in drei Größen und mit vier in höheverstellbaren Bodengleiters.

sizes Maxima tables:  
103 x 103 cm  
180 x 93 cm  
240 x 103 cm



# MAXIMA

backless bench & hocker



Maxima hocker, Noor table 320 x 100 cm



- De Maxima backless (rugloze) bench is geschikt voor zowel binnen als buiten. De Maxima hocker kan eventueel ook als bijzettafel dienst doen.
- The Maxima backless bench is suitable for both in- and outdoor. The matching hocker can also be used as a side table.
- Die Maxima backless bench ist gleichermaßen für drinnen wie draußen geeignet. Der beipassende Hocker kan auch als Beistelltisch dienen.

sizes : 40 x 39 cm  
100 x 39 cm  
180 x 39 cm

Cushion code: CBM40 - CBM100 - CBM180



Maxima backless bench 180 cm, Maxima table 240 x 100 cm and Noah stacking chair - black

# NOAH

stacking chair



Noah stacking chair - black, Noah table 243 x 91 cm



Available colors:

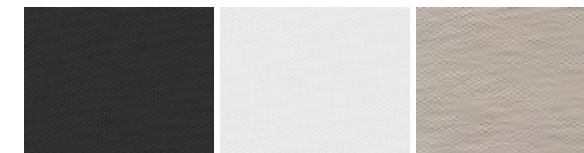

Black

White

Taupe

- De Noah stacking chair is bijzonder licht in gewicht en stapelbaar tot 6 stoelen. Het frame voor de Batyline® bespanning is gemaakt van gepoedercoat staal.
- The clean sleek contemporary lines of the Naoh stacking chair make the chair an extreem elegant item. The chair is very light and can be stacked upon 6 chairs.
- Der Noah stacking chair hat das Perfekt Erscheinungsbild mit selbstverständlicher Eleganz. Der Noah Stapelstuhl ist besonders leicht im Gewicht und ist bis zu 6 Stühle stapelbar.





- De Noah table is door de combinatie van RVS met massief teakhouten planken een streling voor het oog. De tafel is voorzien van vier in hoogte verstelbare beschermdoppen.
- The Noah table lives up to the high expectations of the modern times. The table is equipped with four in height adjustable gliders.
- Die Noah Table ist durch die Kombination von Edelstahl mit Teakplanken ein Fest für die Augen. Die vier schlanken Beine mit in höheverstellbaren bodengleiters tragen die massiven Teak Platten.

size Noah table : 243 x 91 cm



**NOAH**  
table

Noah stacking chair - white and taupe, Noah table 243 x 91 cm

# VICTORIA

recliner



Victoria recliner, Maxima tabel 240 x 103 cm  
Sisi table 40 x 40 cm



- De Victoria recliner heeft een in 7 standen verstelbare rug, is volledig opvouwbaar en daardoor handig op te bergen. Door het gebruik van RVS beslag krijgt deze recliner een moderne uitstraling.
- The Victoria recliner has a backrest which is adjustable in 7 different positions, is foldable and therefore easy to store. The recliner has a more modern look due to stainless steel fittings.
- Dieser elegante recliner aus Teak hat eine Rücklehne welche in 7 positionen verstellbar ist. Alle Beschläge sind aus Edelstahl für ein leichtgängiges Klappen und eine lange Lebensdauer. Der Victoria recliner ist komplett zusammenklappbar, und so leicht zu verstauen.

Cushion code: CR123 - CRE123 - CRM123



# VICTORIA

folding armchair



Victoria folding armchair, Alexia table 130 x 70 cm



- Victoria folding armchair heeft een handzaam formaat, is licht in gewicht, opvouwbaar en blijft ingeklapt zelfstandig staan.
- The Victoria folding arm chair is distinguished by its simple, solid design and traditional woodworking techniques. When folded the chair can stand on its own in an upright position.
- Durch die handliche Größe und das geringe Gewicht kan der Klappbare Victoria folding armchair an vielen Orten verwendet werden. Darüber hinaus bleibt der Stuhl im gefalteten Zustand selbständig stehen.

Cushion code: CF47 - CFE47



Victoria folding armchair with CF47 cushion, Theodora table 150 x 90 cm



Victoria folding chair, Theodora table 90 x 90 cm

# VICTORIA

folding chair



- De rugleuning geeft comfortabele steun in de rug, bovendien is de zitting ergonomisch gevormd voor een beter comfort.
- The Victoria folding chair is one of the most functional chairs because of its convenient size, its light weight and easy folding up system, it can be used in many different locations in your garden.
- Die Rückenlehne des klassischen Teakstuhls reichen bis zur Schulter und stützen so angenehm den Rücken, die Sitzfläche ist ergonomisch geformt.

Cushion code: CF47 - CFE47

# VICTORIA

stacking chair



Victoria stacking chair with CC50 cushions, Soraya table 200 x 100 cm



- De Victoria stacking chair is al jaren populair, een elegante verschijning met elegant en vloeiend vormgegeven rug en zitting, voor een perfect zitcomfort.
- The Victoria stacking chair has been popular for many years, an traditional model with elegant and smooth shaped seat and back, for a perfect seating comfort.
- Der Victoria stacking chair ist seit Jahren beliebt, ein elegant aussehender Stapelstuhl mit ergonomisch modelliertem Sitz und Rücken, elegant und komfortable für den perfekten Sitzkomfort.

Cushion code: CC50 - CCE50

# VICTORIA

bench



- Door het prachtige design, de golvende armleningen en de ergonomisch gevormde rug- en zitgedeelte is de Victoria bench een blijvende schoonheid.
- It's beautiful design, the waving armrests and ergonomically shaped backrest and seat make the Victoria bench a lasting beauty.
- Die elegante und anmutige Victoria bench aus Teak, verbreitet ländische Idylle und erhält dauerhaft ihre Schönheit.

sizes Victoria bench:

- 125 cm
- 155 cm
- 185 cm
- 215 cm
- 245 cm

**Cushion code:** CB120 - CBE120  
CB150 - CBE150  
CB180 - CBE180  
CB215 - CBE215  
CB245 - CBE245



Victoria bench 155 and 125 cm



Victoria deckchair



# VICTORIA

deckchair

- De rugleuning van de Victoria deckchair is verstelbaar in verschillende comfortabele posities. RVS beslag voor modernere uitstraling. De deckchair is leverbaar met en zonder wielen.
- The backrest of the Victoria deckchair is adjustable in different comfortable positions. The use of stainless steel gives the deckchair a more modern look. The deckchair is available with and without wheels.
- Die Rückenlehne von dem Victoria deckchair is in verschiedene komfortabele Positionen einstellbar. Die Verwendung von Edelstahl gibt dem Deckchair eine moderne Ausstrahlung. Der Liegestuhl ist verfügbar mit und ohne Räder.

Cushion code: CD185 - CDE185 - DCD185 - CDM185



Noor table 320 x 100 cm, Victoria stacking chair with CC50 cushions

# N

oor  
table



- De 320 cm Noor table is de langste tafel in onze collectie, maar is ook leverbaar in een 240 cm uitvoering. In de tafel zijn RVS onderdelen in de massieve constructie verwerkt, dit zorgt ervoor dat de tafel zijn originele vorm behoudt.
- The 320 cm Noor table is the longest table in our collection. The table is also available in 240 cm length. It is a very solid table, an ingenious construction prevents sagging.
- Der 320 cm lange Noor Tisch ist der größte in unsere Kollektion. Beim sehr soliden Noor Tisch sind wartungsfreie Edelstahlteile aufwändig in das massive Teakholz eingearbeitet dies hält den Tisch zuverlässig in Form.

sizes Noor table :            240 x 100 cm  
    320 x 100 cm



# ALEXIA

recliner



- Deze comfortabele stoel is in 7 standen verstelbaar, volledig opvouwbaar en daardoor handig op te bergen. Door het gebruik van RVS beslag krijgt deze recliner een moderne uitstraling.
- This comfortable chair has an adjustable back (7 positions), is foldable and therefore easy to store. The recliner has a more modern look due to stainless steel fittings.
- Dieser elegante Hochlehner hat eine verstellbare Rücklehne (7 positionen), ist komplett zusammenklappbar, und so leicht zu verstauen. Die Beschläge sind aus Edelstahl für ein leichtgängiges Klappen und eine lange Lebensdauer.

Cushion code: CR123 - CRE123 - CRM123



William table 130 cm, Alexia recliner



- De golvende vormen van de Alexia folding armchair zijn een garantie voor extra zitcomfort. De lichtgewicht stoel is volledig opklapbaar en blijft ingeklapt zelfstandig staan.
- The undulating shapes of Alexia folding armchair are a guarantee for extra comfort. The lightweight chair is fully foldable and stands independently when folded.
- Die Wellenform des Sitzes beim Alexia folding armchair ist die Garantie für zusätzlichen Komfort. Der Aufklappbare Sessel bleibt zusammengeklappt selbstständig stehen.

Cushion code: CF47 - CFE47



Alexia folding chair, Alexia folding table 70 x 70 cm

**ALEXIA**  
folding armchair



Alexia folding armchair, Alexia folding table 70 x 70 cm



# ALEXIA

folding table



- De Alexia folding table is een veelzijdige, stabiele en eenvoudig op te klappen tafel. De tafel is in 2 maten verkrijgbaar.
- The Alexia folding table is fully foldable and will stand independently when folded. The table is available in 2 sizes.
- Der stabile Klapp Tisch Alexia ist einfach und praktisch zusammen zu klappen und kann mit einfachen Handgriffen aufgebaut werden. Der Tisch ist in 2 Maße erhältlich.

sizes Alexia table : 70 x 70 cm  
130 x 74 cm



# FLORIS

table

Floris table 213 x 91 cm, Carlos stacking chairs



- Vier slanke poten dragen het smalle frame met de massief teakhouten panelen, waardoor alles één geheel lijkt. De 4 poten zijn demontabel.
- Four slender legs wearing the narrow frame with teak panels, make this a beautiful combination. The 4 legs are demountable.
- Vier schlanke Beine tragen die massiven Teak Platten, die mit der Zarge darunter wie aus einem Guss wirkt. Die 4 Tischbeinen sind demontierbar.

sizes Floris table: 91 x 91 cm  
 152 x 91 cm  
 213 x 91 cm

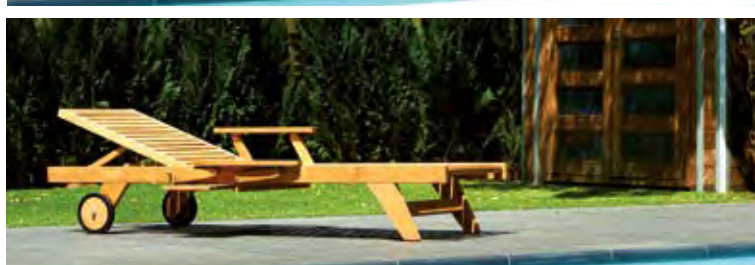

- De Leah lounge is een zeer compleet ligbed. Deze lounge is voorzien van een verstelbaar rug- en voetgedeelte, een uitschuiftafel (aan 2-kanten), wielen en opklapbare armleuningen.
- The Leah lounge is equipped with an adjustable back and footrest, an extendable table (on 2 sides), wheels and 2 folding armrests.
- Der Leah lounge ist eine sehr komplette Liege. Diese Liege hat eine verstellbare Rückenlehne und Beinstütze, Schiebetisch (für 2 Seiten), Räder und klappbare Armlehnen.

Cushion code: CL200- CLE200 - DCL200 - CLM200



**L**EAH  
lounger

Leah lounge with CL200 cushion

# WILHELMINA

bench



Wilhelmina bench 262 cm



- De klassieke vormen en elegante golven van deze bank maken de Wilhelmina Lutyens bench een blikvanger in elke tuin. Deze originele, exclusieve bank is leverbaar in 2 formaten; 196 en 262 cm.
- The classic shapes and elegant waves of this exclusive bench make Wilhelmina Lutyens bench an eyecatcher in any garden. This original exclusive bench is available in 2 sizes, 196 and 262 cm.
- Die klassischen eleganten Formen dieser exklusiven Gartenbank sind ein Blickfänger in jedem Garten. Diese Originale und exklusiven Wilhelmina Lutyens bench ist in 2 Größen lieferbar; 196 und 262 cm.

sizes Wilhelmina bench: 196 cm  
262 cm

Cushion code: CBW195- CBW262

# LILLY

side table



- Deze multifunctionele, lichtgewicht, tafel is volledig inklapbaar en zowel in een vierkante als ronde vorm verkrijgbaar.
- This multifunctional fully foldable sidetable is in a square and a round shape available.
- Dieser multifunktionale klappbare Bei-stelltisch ist sowohl in quadratischer als auch in runder Form Verfügbar.

sizes Lilly table : 52 x 52 cm  
Ø 62

# SISI

side table



- Waarin een kleine tafel groot kan zijn: overal inzetbaar, multi-functioneel, lichtgewicht, gemakkelijk op te bergen.
- How a small table can make a big contribution: can be used anywhere, multifunctional, lightweight and easy to store.
- Wie ein kleiner Tisch groß sein kann: überall einsetzbar, bequem, leicht und multifunktional.

sizes Sisi table: 40 x 40 cm  
50 x 50 cm

# SORAYA

table



Soraya table 200 x 100 cm, Victoria stacking chair with CC50 cushions



- Deze massieve familietafel is ruim, solide en geënt op een authentiek stuk vakmanschap.
- This massive family table is very spacious, solid and crafted on an authentic piece of craftsmanship.
- Mit einem Tischplattenmaß von 200 x 100 cm verfügt der Gartentisch über genug Platz, um Tisch-dekoration und Geschirr perfekt in Szene zu setzen.

size Soraya table: 200 x 100 cm





- De Alexandra deckchair heeft een verstelbare rugleuning en een comfortabele voetenbank en is leverbaar met en zonder wielen.
- The Alexandra deckchair has an adjustable backrest and a comfortable footrest and is available with or without wheels.
- Die Rückenlehne ist in verschiedenen komfortablen Positionen einstellbar während die Armlehnen für eine zusätzliche Bequemlichkeit sorgen. Der Alexandra deckchair ist mit oder ohne Räder verfügbar

Cushion code: CD185 - CDE185 - DCD185 - CDM185

# ALEXANDRA

deckchair



Alexandra deckchair with DCD185 cushion

# THEODORA

table



Theodora table 150 x 90 cm, Kate folding chair - white/black



- Een klassieke Engelse tuintafel, veelzijdig, stabiel en plaatsbesparend op te bergen door 4 demonteerbare poten, allen voorzien van 4 in hoogte verstelbare beschermdoppen.
- A classic English garden table, allround and extremely stable and because of the easy disassembly of the 4 legs, the Theodora table is space saving to store. The tables are also equipped with 4 in height adjustable gliders
- Ein klassischer Englischer Gartentisch, vielseitig und sehr stabil. Der Theodora Tisch ist platzsparend auf zu bewahren durch einfaches demontieren der 4 Tischbeine die zusätzlich mit in höheverstellbaren Bodengleiters ausgestattet sind.

sizesTheodora table : 90 x 90 cm  
150 x 90 cm  
180 x 90 cm



# BEATRICE

treebench



Beatrice treebench 360°



- De Beatrice bench, een bank van 360°, zodat u altijd op het beste plekje onder de boom kunt ontspannen. De bank is tevens leverbaar in een 180° uitvoering (1/2)
- The Beatrice treebench is generously proportioned for comfort and designed to fit 360° around the tree.
- Beatrice treebench, mit der runden Baumbank von Traditional Teak sitzen Sie wunderbar bequem und können Ihren Garten noch schöner genießen.

sizes Beatrice treebench: 180°  
360°



# ANNA bench



- De Anna bench past met bescheiden elegantie in elk tuinontwerp. De rug-latten gaan zonder overgang met een beproefde pen- en gatverbinding elegant over in de dwarsbalk.
- A modest elegant design makes the Anna bench fit in any garden. The backslats go (without transition) with a proven mortise and tenon joint elegantly over in the crossbar.
- Die Anna bench fügt sich mit einer schlichten Eleganz aus Teak in jede Gartengestaltung ein. Die Leisten des Rückens gehen elegant und sanft mit altbewährten Zapfenverbindungen über in die Querstreben.

sizes Anna bench: 120 cm  
150 cm

**Cushion code:** CB120 - CBE120  
CB150 - CBE150



Anna bench 150 cm with CD45

# WILLIAM

table



William table 130 cm, Alexia recliners

- De William table is tijdloos, eenvoudig en gemaakt uit massief teakhout. Er is een aangename hoeveelheid beenruimte en het tafelblad is verkrijgbaar tot een diameter van 150 cm.
- The William table is timeless, simple and made of solid teak. Comfortable legroom and a table top available up to a diameter of 150 cm.
- Der William table ist Zeitlos, schlicht und aus massivem Teakholz gefertigt. Ein bequeme Beinfreiheit und eine Tischplatte mit einem Durchmesser von bis zu 150 cm.

sizes William table : Ø 100 cm  
Ø 130 cm  
Ø 150 cm





Manon table Ø 70 cm



Elips 100 x 70 cm

- Deze moderne Manon tables zijn verkrijgbaar in 5 verschillende maten en gemaakt van massief A-kwaliteit teakhout.
- These modern Manon tables come in 5 sizes and is made of the finest A-grade Teakwood.
- Diese modernen Manon Beistelltische sind verfügbar in 5 verschiedene Abmessungen.

sizes Manon tables: Elips 100 x 70 - 36,5 cm height  
 Ø 35 - 37,5 cm height  
 Ø 40 - 40,5 cm height  
 Ø 45 - 43,5 cm height  
 Ø 70 - 46 cm height



Manon table Ø 45 / 40 / 35 cm

# CUSHIONS COLLECTION

Traditional Teak heeft een uitgebreid assortiment aan kussens, leverbaar in verschillende stof-designs en kleuren van Sunbrella®. Al meer dan 50 jaar is Sunbrella® de absolute nummer 1 in textiel voor tuinmeubelen. De kleuren van Sunbrella® blijven mooi en helder, zelfs als ze blootgesteld worden aan veel zonlicht. Voor informatie over de kleuren, modellen, levertijden en prijzen vraag na bij uw dealer. ([www.traditionalteak.nl](http://www.traditionalteak.nl))

Traditional Teak can offer you a range of cushions, which are available in a wide collection of colors/designs of Sunbrella®. Sunbrella® has become widely adopted for shade structures, marine canvas and upholstery fabric for both outdoor and indoor applications. All Sunbrella® fabrics are engineered to combine the highest level of design and performance, the fabrics are treated with a proprietary water and stain repellent finish that is designed to last for several years. please ask your local dealer for available fabrics, models and prices. ([www.traditionalteak.nl](http://www.traditionalteak.nl))

Traditional Teak hat eine umfangreiche Kissen Kollektion, lieferbar in verschiedene Sunbrella® Muster und Farben. Seit mehr als 50 Jahren ist Sunbrella® die absolute Nummer 1 bei Textilien für Gartenmöbel. Der Stoff fühlt sich angenehm an und ist dennoch haltbar, zeichnet sich durch Umwelteigenschaften aus, die in der Branche führend sind, lässt sich leicht pflegen und hält sehr lange – egal, wo das Material eingesetzt wird. Bitte fragen Sie Ihrem Händler nach den Möglichkeiten für Muster, Modelle, aktuelle lieferzeiten und Preisen. ([www.traditionalteak.nl](http://www.traditionalteak.nl))

**Sunbrella®: UV resistant, water and stain resistant, breathable, mold resistant, easy to maintain.**



# CUSHIONS

## MODELS



Traditional (model 01)

- 50mm schuim - Foam - Schaumstoff
- 200g/qm vlies omwikkeld - wrapped with fleece - Vlies ummantelt
- volant - volant - Stehsaum
- hoofdkussen - neckcushion - Kopfkissen
- gecapitonneerd - padded - gesteppt



Design (model 02)

- 50mm schuim - Foam - Schaumstoff
- 200g/qm vlies omwikkeld - wrapped with fleece - Vlies ummantelt
- met rits - with zipper - mit Reisverschluss
- uitneembare vulling - removable filling - Kissen abziehbar



Michelin (model 03)

- 20mm schuim - Foam - Schaumstoff
- 200g/qm vlies omwikkeld - wrapped with fleece - Vlies ummantelt
- volant - volant - Stehsaum
- gestikte compartimenten - stitched compartments - Teilungen sind als Durchnaht ausgeführt.
- met rits - with zipper - mit Reisverschluss
- uitneembare vulling - removable filling - Kissen abziehbar



Elegant (model 04)

- 50mm schuim - Foam - Schaumstoff
- 200g/qm vlies omwikkeld - wrapped with fleece - Vlies ummantelt
- volant - volant - Stehsaum
- met rits - with zipper - mit Reisverschluss
- uitneembare vulling - removable filling - Kissen abziehbar



Maxima (model 05)

- 40mm schuim - Foam - Schaumstoff
- 200g/qm vlies omwikkeld - wrapped with fleece - Vlies ummantelt
- met rits - with zipper - mit Reisverschluss
- uitneembare vulling - removable filling - Kissen abziehbar

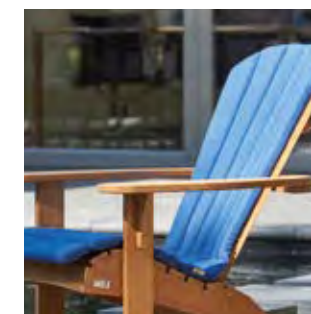

Sienna (model 06)

- 20mm schuim - Foam - Schaumstoff
- 200g/qm vlies omwikkeld - wrapped with fleece - Vlies ummantelt
- gestikte compartimenten - stitched compartments - Teilungen sind als Durchnaht ausgeführt.



# CUSHIONS

model & code

Description	Collection	Art. code Traditional (model 01)	Art. code Design (model 02)	Art. code Michelin (model 03)	Art. code Elegant (model 04)	Art code Maxima (model 05)	Art. code Sienna (model 06)
Cushion for bench 120 cm	Victoria, Anna	CB120			CBE120		
Cushion for bench 150 cm	Victoria, Anna, Sarah, Kate	CB150			CBE150		
Cushion for bench 180 cm	Victoria, Anna, Sarah	CB180			CBE180		
Cushion for bench 215 cm	Victoria	CB210			CBE210		
Cushion for bench 245 cm	Victoria	CB245			CBE245		
Cushion for hocker	Maxima					CBM40	
Cushion for backless bench 90 cm	Luna					CBL90	
Cushion for backless bench 100 cm	Maxima					CBM100	
Cushion for backless bench 167 cm	Moritz					CBM167	
Cushion for backless bench 180 cm	Maxima					CBM180	
Cushion for backless bench 202 cm	Luna					CBL202	
Cushion for corner bench Maxima	Maxima					CMCB	
Cushion for stacking chair	Maxima, Grace, Luna					CCM	
Cushion for stacking chair	Carlos					CCN	
Cushion for stacking chair	Victoria	CC50			CCE50		
Cushion for folding Chairs	Victoria, Alexia, Kate	CF47			CFE47		
Cushion for Recliners	Victoria, Alexia, Kate	CR123		CRM123	CRE123		

Description	Collection	Art. code Traditional (model 01)	Art. code Design (model 02)	Art. code Michelin (model 03)	Art. code Elegant (model 04)	Art code Maxima (model 05)	Art. code Sienna (model 06)
Cushion for bench Maxima 155	Maxima					CM155	
Cushion for bench Maxima 155 - without 1 armrest	Maxima					ACM155	
Cushion for bench Maxima 155 - without 2 armrests	Maxima					ACM155-2	
Cushion for bench Maxima 180	Maxima					CM180	
Cushion for bench Maxima 180 - without 1 armrest	Maxima					ACM180	
Cushion for bench Maxima 180 - without 2 armrests	Maxima					ACM180-2	
Cushion for bench Maxima 215	Maxima					CM215	
Cushion for bench Maxima 215 - without 1 armrest	Maxima					ACM215	
Cushion for bench Maxima 215 - without 2 armrests	Maxima					ACM215-2	
Cushion for Loungers	Leah, Luna, Kate	CL200	DCL200	CLM200	CLE200		
Cushion for Deckchairs	Victoria, Alexandra, Kate	CD185	DCD185	CDM185	CDE185		
Cushion for Sienna Beach chair	Sienna, Sienna-mosaic						SBC

# MAINTENANCE



## TEAK CLEANER and BRIGHTENER 1 & 2

Om grijs verkleurde teakmeubelen schoon te maken en schimmels en algen te doden binnen in het teakhout. Teak Cleaner and Brightener 1 & 2 is niet alleen een cleaner, maar heeft ook oplichtende ingrediënten, wat de originele honingbruine kleur van het teakhout weer terugbrengt.

To clean discoloured grey teak and to bring it back to its original honey brown colour. This is not only a cleaner but is also equipped with lighting ingredients, which brings back the original colour of teak.

Um Grau verfärbtes Teakholz wieder sauber zu machen, Pilze und Algen im Teakholz abzutöten und in seine ursprünglichen Honigbraune Farbe zurück zu bringen. Teak Cleaner and Brightener 1 & 2 ist nicht nur ein hervorragender Reiniger, sondern auch mit aufhellende Zutaten ausgestattet, was die Farbe des Teakholzes wieder auffrischt.



## TEAK SEALER 3

Met Teak Sealer 3 behoudt teak de honingbruine kleur voor een langere periode en het voorkomt zwarte vlekken. Teak Sealer 3 van Traditional Teak is op waterbasis, niet vet en vlekt niet.

Teak Sealer 3 retains the honey brown colour of teak for a longer period of time and prevents black spots. Teak Sealer 3 from Traditional Teak is waterbased, not greasy and doesn't spot.

Teak Sealer 3 behält die Honigbraune Farbe des Teakholzes über einen längeren Zeitraum. Der Teak Sealer 3 von Traditional Teak ist auf Wasserbasis, nicht fettig und Fleckt nicht.



## TEAK PATINA SHIELD 4 & 5

Een kleurloze beschermer die voorkomt dat etensresten het teak binnendringen, het beschermt het hout tegen vocht en regen en voorkomt dat het teakhout vies wordt.

A colourless protector that prevents food to penetrate the teak and cause stains, it protects the wood from moisture, rain and by doing so, prevents the teak from getting dirty.

Eine transparente Lasur, die verhindert dass Lebensmittel in das Teakholz durchdringen und Flecken verursachen, er schützt das Holz gegen Feuchtigkeit, Regen und verhindert damit dass das Teakholz schmutzig wird.

See our website for instructions how to use our maintenance products: [www.traditionalteak.nl](http://www.traditionalteak.nl)

# DETAILS

All variations,  
sizes & codes

Maten en gewichten vermeld in deze catalogus, zijn indicatief en kunnen variëren. Alle genoemde prijzen zijn onder voorbehoud van druk- en zetfouten.

Sizes and weights mentioned in this catalogue are indicative and may vary. All prices are subject to misprints.

Größen und Gewichten in diesem Katalog sind nur Richtwerte und können variieren. Alle Preise verstehen sich vorbehaltlich Druckfehler.



Suitable for all deckchairs

deckchair wheelset  
8.99.30.10.00

## ALEXANDRA (pg 112)



ALEXANDRA deckchair  
8.99.01.10.00 (without wheels)  
8.99.01.10.00a (with wheels)

w	d	h	kg
170	60	95	15

## ALEXIA (pg 96)



ALEXIA folding armchair  
8.99.01.4.00

w	d	h	kg
63	59	90	9



ALEXIA recliner  
8.99.01.4.01

w	d	h	kg
61	68	114	11

## ANNA (pg 118)

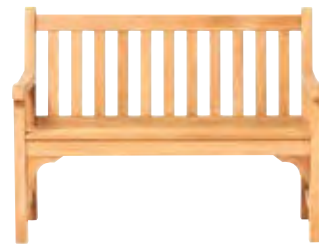

ANNA bench 120 cm  
8.99.10.3.00

w	d	h	kg
120	65	94	18

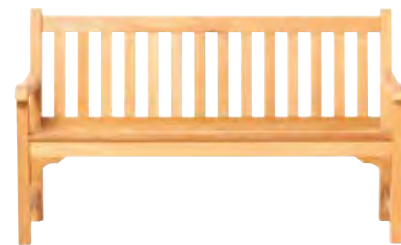

ANNA bench 150 cm  
8.99.10.3.01

w	d	h	kg
150	65	94	20



ALEXIA folding square table 70 x70 cm  
8.99.20.4.00

w	d	h	kg
70	70	74	7



ALEXIA folding table 130 x 74 cm  
8.99.20.4.01

w	d	h	kg
130	74	74	15

## BEATRICE (pg 116)



BEATRICE tree bench  
8.99.10.10.03 (bench 180°)  
8.99.10.10.00 (bench 360°)

w	d	h	kg
210	84	90	74 / 37

## BARON (pg 46)



BARON bench 180 cm  
8.99.10.21.00

w	d	h	kg
180	66	91	38

## DIANA (pg 52)



*Diana*  
**aluminum white legs**

DIANA table Ø 95 cm  
7.99.20.15.00 TL (**teak legs**)  
7.99.20.15.00 ALA (**antracite legs**)  
7.99.20.15.00 ALW (**white legs**)

Ø	h	kg
95	76	15



*Diana*  
**aluminum antracite legs**

DIANA table Ø 125 cm  
7.99.20.15.01 TL (**teak legs**)  
7.99.20.15.01 ALA (**antracite legs**)  
7.99.20.15.01 ALW (**white legs**)

Ø	h	kg
125	76	24



*Diana*  
**teak legs**

DIANA table Ø 145 cm  
7.99.20.15.02 TL (**teak legs**)  
7.99.20.15.02 ALA (**antracite legs**)  
7.99.20.15.02 ALW (**white legs**)

Ø	h	kg
145	76	30

## CARLOS (pg 38)



CARLOS stacking chair  
7.99.01.20.00

w	d	h	kg
54	57	84	7



*Diana mosaic-teak* coffee table /  
**teak legs**

DIANA **mosaic** coffee table  
M- 7.99.20.15.07 (**teak legs**)

Ø	h	kg
80	44	9.5



*Diana mosaic-teak* side table /  
**teak legs**

DIANA **mosaic** side table  
M- 7.99.20.15.06 (**teak legs**)

Ø	h	kg
50	36	5

## DIANA mosaic (pg 54)



*Diana mosaic-teak*  
**aluminum white legs**

DIANA **mosaic-teak** table Ø 95 cm  
M-7.99.20.15.03 TL (**teak legs**)  
M-7.99.20.15.03 ALA (**antracite legs**)  
M-7.99.20.15.03 ALW (**white legs**)

Ø	h	kg
95	76	15



*Diana mosaic-teak*  
**aluminum antracite legs**

DIANA **mosaic-teak** table Ø 125 cm  
M-7.99.20.15.04 TL (**teak legs**)  
M-7.99.20.15.04 ALA (**antracite legs**)  
M-7.99.20.15.04 ALW (**white legs**)

Ø	h	kg
125	76	24



*Diana mosaic-teak*  
**teak legs**

DIANA **mosaic-teak** table Ø 145 cm  
M-7.99.20.15.05 TL (**teak legs**)  
M-7.99.20.15.05 ALA (**antracite legs**)  
M-7.99.20.15.05 ALW (**white legs**)

Ø	h	kg
145	76	30

## FLORIS (pg 102)



FLORIS table 91 x 91 cm  
7.99.20.12.00

w	d	h	kg
91	91	76	32

FLORIS table 152 x 91 cm  
7.99.20.12.01

w	d	h	kg
152	91	76	39

FLORIS table 213 x 91 cm  
7.99.20.12.02

w	d	h	kg
213	91	76	54

## GRACE



GRACE stacking chair  
7.99.01.11.00

w	d	h	kg
58	61	83	8

## KATE (pg 14)



KATE folding chair  
black 8.99.01.2.21  
white 8.99.01.2.22  
taupe 8.99.01.2.23

w	d	h	kg
48	69	93	7



KATE folding armchair  
black 8.99.01.2.09  
white 8.99.01.2.10  
taupe 8.99.01.2.11

w	d	h	kg
58	69	93	8

## GRACE (pg 10)

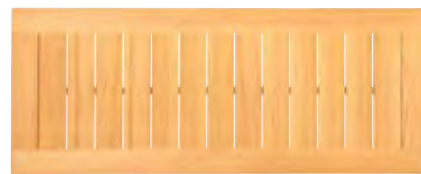
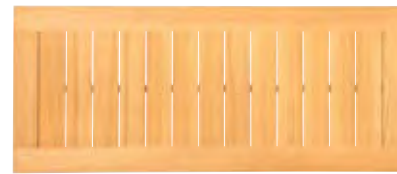
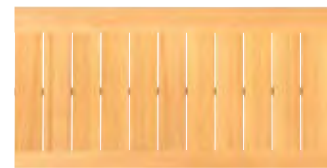

GRACE table 191 x 100 cm  
7.99.20.11.00

w	d	h	kg
191	100	76	54

GRACE table 240 x 100 cm  
7.99.20.11.01

w	d	h	kg
240	100	76	62

GRACE table 300 x 100 cm  
7.99.20.11.02

w	d	h	kg
300	100	76	76



KATE recliner  
black 8.99.01.2.00  
white 8.99.01.2.02  
taupe 8.99.01.2.04

w	d	h	kg
65	64	116	9



KATE stacking chair  
black 8.99.01.2.06  
white 8.99.01.2.07  
taupe 8.99.01.2.08

w	d	h	kg
59	59	91	9



KATE footstool  
black 8.99.01.2.01  
white 8.99.01.2.03  
taupe 8.99.01.2.05

w	d	h	kg
47	48	46	4

## KATE (pg 14)



KATE director chair  
 black 8.99.01.2.18  
 white 8.99.01.2.19  
 taupe 8.99.01.2.20

w	d	h	kg
60	60	92	8



KATE relax chair  
 black 8.99.01.2.12  
 white 8.99.01.2.13  
 taupe 8.99.01.2.14

w	d	h	kg
63	100	93	6



KATE deckchair  
 black 8.99.01.2.24  
 white 8.99.01.2.25  
 taupe 8.99.01.2.26

w	d	h	kg
60	170	95	12



KATE bench 150 cm  
 black 8.99.01.2.36  
 white 8.99.01.2.37  
 taupe 8.99.01.2.38

w	d	h	kg
150	67	88	17



KATE neckroll  
 black 8.99.01.2.27  
 white 8.99.01.2.28  
 taupe 8.99.01.2.29

w	d	h	kg
31	14	7	1

## LEAH (pg 104)



LEAH lounger  
 8.99.01.10.01

w	d	h	kg
64	207	31	35



KATE Lazy lounge chair  
 black 8.99.01.2.30  
 white 8.99.01.2.31  
 taupe 8.99.01.2.32

w	d	h	kg
65	84	80	8.5



KATE Lazy lounge footstool  
 black 8.99.01.2.34  
 white 8.99.01.2.35  
 taupe 8.99.01.2.36

w	d	h	kg
65	55	35,4	4



KATE lounger  
 black 8.99.01.2.15  
 white 8.99.01.2.16  
 taupe 8.99.01.2.17

w	d	h	kg
64	201	31	19

## LILLY (pg 108)



LILLY square table 52 x 52 cm  
 8.99.20.6.03

w	d	h	kg
52	52	42	6



LILLY round table Ø 62  
 8.99.20.6.02

Ø	h	kg
62	42	5

## LUNA (pg 40)



LUNA side table  
 7.99.20.16.03

w	d	h	kg
50	50	41	6

## LUNA (pg 40)



LUNA backless bench  
7.99.10.16.02

w	d	h	kg
90	38	45	9



LUNA backless bench  
7.99.10.16.01

w	d	h	kg
202	38	45	14



LUNA stacking chair  
black 7.99.01.16.00  
white 7.99.01.16.01  
taupe 7.99.01.16.02  
blue 7.99.01.16.03

w	d	h	kg
54	57	91	6



LUNA lounger  
7.99.01.16.04

w	d	h	kg
69	197	31	12

## MANON (pg 122)



MANON Elips 100 x 70  
7.99.20.13.04

w	d	h	kg
100	70	37	10



*aluminum white legs*

LUNA table 90 x 90 cm  
7.99.20.16.00 TL (*teak legs*)  
7.99.20.16.00 ALA (*antracite legs*)  
7.99.20.16.00 ALW (*white legs*)

w	d	h	kg
90	90	76	14



*aluminum antracite legs*

LUNA table 120 x 120 cm  
7.99.20.16.01 TL (*teak legs*)  
7.99.20.16.01 ALA (*antracite legs*)  
7.99.20.16.01 ALW (*white legs*)

w	d	h	kg
120	120	76	24



*teak legs*

LUNA table 217 x 90 cm  
7.99.20.16.02 TL (*teak legs*)  
7.99.20.16.02 ALA (*antracite legs*)  
7.99.20.16.02 ALW (*white legs*)

w	d	h	kg
217	90	76	31



MANON table Ø 35  
7.99.20.13.00

Ø	h	kg
35	38	2,5



MANON table Ø 40  
7.99.20.13.01

Ø	h	kg
40	40	3



MANON table Ø 45  
7.99.20.13.02

Ø	h	kg
45	43	4



MANON table Ø 70  
7.99.20.13.03

Ø	h	kg
35	45	7

# MAXIMA (pg 68)



MAXIMA hocker 40 cm  
8.99.01.1.01

w	d	h	kg
40	39	44	13



MAXIMA backless bench 100 cm  
8.99.10.1.01

w	d	h	kg
100	39	44	17



MAXIMA backless bench 180 cm  
8.99.10.1.00

w	d	h	kg
180	39	44	22



MAXIMA table 103 x 103 cm  
8.99.20.1.02

w	d	h	kg
103	103	76	30



MAXIMA table 180 x 93 cm  
8.99.20.1.00

w	d	h	kg
180	93	76	49



MAXIMA table 240 x 103 cm  
8.99.20.1.01

w	d	h	kg
240	103	76	62



MAXIMA bench 155 cm  
8.99.10.1.02 (with arms)  
8.99.10.1.02a (armless)

w	d	h	kg
155	60	88	42



MAXIMA bench 180 cm  
8.99.10.1.03 (with arms)  
8.99.10.1.03a (armless)

w	d	h	kg
180	60	88	48



MAXIMA bench 215 cm  
8.99.10.1.04 (with arms)  
8.99.10.1.04a (armless)

w	d	h	kg
215	60	88	55



MAXIMA stacking chair  
8.99.01.1.02

w	d	h	kg
61	55	88	8



MAXIMA corner bench  
8.99.10.1.05

w	d	h	kg
65	65	88	24



## MAXIMA LOUNGE (pg 60)



MAXIMA lounge chair

7.99.02.1.01

w	d	h	kg
88	81	64	24



MAXIMA lounge bench 3-seater

7.99.02.1.05

w	d	h	kg
239	81	64	57



MAXIMA lounge chair w/o arms

7.99.02.1.02

w	d	h	kg
76	81	64	21



MAXIMA lounge corner cushion

7.99.02.1.07



MAXIMA lounge bench 2-seater Arm-R

7.99.02.1.04R

w	d	h	kg
157	81	64	34



MAXIMA lounge bench 2-seater Arm-L

7.99.02.1.03L

w	d	h	kg
157	81	64	34



MAXIMA lounge hocker

7.99.02.1.06

w	d	h	kg
76	76	40	10

De vermelde prijzen voor de Maxima lounge serie zijn incl. Sunbrella® kussen (solid/stripes). De kussens zijn, tegen meerprijs, in andere Sunbrella® kleuren en designs. Indien u vragen heeft, verwijzen wij u graag naar één van onze dealers of naar onze website [www.traditionalteak.nl](http://www.traditionalteak.nl)

The prices mentioned for the Maxima lounge includes Sunbrella cushions (solid/stripes). The cushions are also available in other Sunbrella® colors and designs (additional costs). If you have any questions, please ask your local dealer or contact us directly [www.traditionalteak.nl](http://www.traditionalteak.nl)

Die Kissen sind im Preis des Möbels enthalten und in verschiedenen Sunbrella® Stoffmuster und Farbtönen verfügbar (solid/stripes). Auch sind die Auflagen mit andere Sunbrella® muster verfügbar. Bei Fragen wenden Sie sich bitte an Ihren Fachhändler oder kontaktieren Sie uns direkt unter [www.traditionalteak.nl](http://www.traditionalteak.nl)

## MORITZ mosaic (pg 50)



MORITZ **mosaic** table 180 x 90 cm  
7.99.20.17.01

w	d	h	kg
180	91	75	47



MORITZ **mosaic** backless bench 168 cm  
7.99.10.17.00

w	d	h	kg
168	35	44	18

## NOOR (pg 94)



NOOR table 240 x 100 cm  
7.99.20.20.00

w	d	h	kg
240	100	76	69



NOOR table 320 x 100 cm  
7.99.20.20.01

w	d	h	kg
320	100	76	80

## NOAH (pg 78)



NOAH stacking chair  
black 7.99.01.14.00  
white 7.99.01.14.01  
taupe 7.99.01.14.02

w	d	h	kg
60	56	88	7



NOAH table 243 x 91 cm  
7.99.20.14.00

w	d	h	kg
243	91	76	60



## SARAH (pg 36)



SARAH bench 155 cm  
8.99.10.4.01

w	d	h	kg
152	65	90	25



SARAH bench 185 cm  
8.99.10.4.02

w	d	h	kg
180	65	90	30

## SIENNA mosaic (pg 58)



SIENNA beachchair **mosaic**  
7.99.01.9.03

w	d	h	kg
75	88	92	15



SIENNA footstool **mosaic**  
7.99.01.9.04

w	d	h	kg
54	51	34	6

## SIENNA (pg 56)



SIENNA beachchair  
7.99.01.9.01

w	d	h	kg
75	88	92	15



SIENNA footstool  
7.99.01.9.02

w	d	h	kg
54	51	34	6

## THEODORA (pg 114)



THEODORA table 90 x 90 cm  
8.99.20.7.00

w	d	h	kg
90	90	74	21



THEODORA table 150 x 90 cm  
8.99.20.7.01

w	d	h	kg
150	90	74	29



THEODORA table 180 x 90 cm  
8.99.20.7.02

w	d	h	kg
180	90	74	33

## SORAYA (pg 110)



SORAYA table 200 x 100 cm  
8.99.20.5.00

w	d	h	kg
200	100	74	55

## SISI (pg 109)



SISI table 40 x 40 cm  
8.99.20.6.00

w	d	h	kg
40	40	42	7



SISI table 50 x 50 cm  
8.99.20.6.01

w	d	h	kg
50	50	42	9

## VICTORIA (pg 82)



VICTORIA recliner  
8.99.01.0.03

w	d	h	kg
61	68	114	13



VICTORIA folding armchair  
8.99.01.0.02

w	d	h	kg
61	63	95	9



VICTORIA folding chair  
8.99.01.0.01

w	d	h	kg
43	62	90	8

## VICTORIA (pg 82)



VICTORIA bench 125 cm  
8.99.10.0.00

w	d	h	kg
125	65	94	22

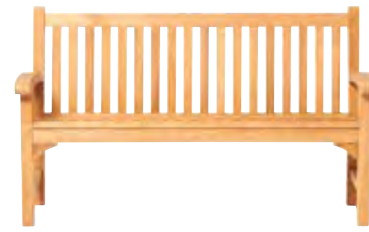

VICTORIA bench 155 cm  
8.99.10.0.01

w	d	h	kg
155	65	94	28

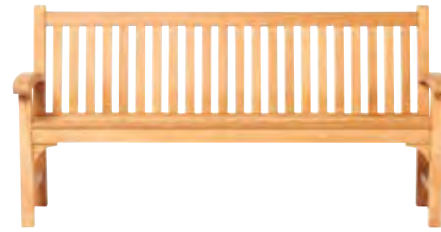

VICTORIA bench 185 cm  
8.99.10.0.02

w	d	h	kg
185	65	94	34



VICTORIA bench 215 cm  
8.99.10.0.03

w	d	h	kg
215	65	94	40



VICTORIA bench 245 cm  
8.99.10.0.04

w	d	h	kg
245	65	94	50



VICTORIA stacking chair  
8.99.01.0.00

w	d	h	kg
63	60	90	12



VICTORIA deckchair  
8.99.01.0.04 (without wheels)  
8.99.01.0.04a (with wheels)

w	d	h	kg
62	150	96	21



Suitable for all deckchairs

deckchair wheelset  
8.99.30.10.00



WILHELMINA bench 196 cm  
8.99.10.10.01

w	d	h	kg
196	60	107	41



WILHELMINA bench 262 cm  
8.99.10.10.02

w	d	h	kg
262	60	107	55

## WILHELMINA (pg 106)

## WILLIAM (pg 120)



WILLIAM table Ø 100 cm  
8.99.20.8.00

Ø	h	kg
100	74	30



WILLIAM table Ø 130 cm  
8.99.20.8.01

Ø	h	kg
130	74	42



WILLIAM table Ø 150 cm  
8.99.20.8.02

Ø	h	kg
150	74	54

Maten en gewichten vermeld in deze catalogus, zijn indicatief en kunnen variëren. Alle genoemde prijzen zijn onder voorbehoud van druk- en zetfouten.

Sizes and weights mentioned in this catalogue are indicative and may vary. All prices are subject to misprints.

Größen und Gewichten in diesem Katalog sind nur Richtwerte und können variieren. Alle Preise verstehen sich vorbehaltlich Druckfehler.

## MAINTENANCE (pg 128)



Teak Cleaner and Brightener 1&2  
TT001



Teak PatinaShield 4&5  
TT003



Teak Sealer 3  
TT002



Easy scrub  
TT011

Onze onderhoudsproducten leveren hoge prestaties en zijn volledig veilig en milieuvriendelijk, vrij van oplosmiddelen (VOC's) en gemaakt op waterbasis.

Our maintenance products deliver a high performance and are completely safe and environmentally friendly, are free of solvents (VOCs), and waterbased.

Unsere Pflegemittel liefern hohe Leistungen, sind absolut Sicher, Umwelfreundlich, und sind frei von Lösungsmitteln (VOC), und auf Wasserbasis.

## PREMIUM COVERS

## CODE

Table 100/103 x 100/103cm

(TC 1010)

Table 191 x 100 cm

(TC 1910)

Table 200 x 100 cm

(TC 2010)

Table 240 x 100/103 cm

(TC 2410)

Table 320 x 100 cm

(TC 3210)

Table 90/91 x 90/91 cm

(TC 9090)

Table 150/152 x 90/91 cm

(TC 1590)

Table 180 x 90/93 cm

(TC 1890)

Table 213 x 91 cm

(TC 2190)

Table 242 x 91 cm

(TC 2490)

Table 304 x 91 cm

(TC 3090)

Round Table Ø 100 cm

(TCR 100)

Round Table Ø 130 cm

(TCR 130)

Round Table Ø 150 cm

(TCR 150)

Umbrella cover for umbrellas from Ø 200 - 400 cm

( UC 200 )

Maten en gewichten vermeld in deze catalogus, zijn indicatief en kunnen variëren. Alle genoemde prijzen zijn onder voorbehoud van druk- en zetfouten.

Sizes and weights mentioned in this catalogue are indicative and may vary. All prices are subject to misprints.

Größen und Gewichten in diese Katalog sind nur Richtwerte und können variieren. Alle Preise verstehen sich vorbehaltlich Druckfehler.

# premium COVERS

### *En de traditie gaat verder...*

Alle producten van Traditional Teak zijn handgemaakt en voldoen dus aan hoge kwaliteitseisen, zo ook onze premium tuinmeubel-covers. Gemaakt van een polyurethaan gecoate stof, ademend, zeer beschermend voor het oppervlak en gemakkelijk in het gebruik.

Speciaal ontworpen voor uw waardevolle tuinmeubelen.

**de premium covers zijn:** Waterdicht - UV gestabiliseerd - vorstbestendig - wasbaar tot 30° C - eenvoudig opvouwbaar.

### *And the tradition continues...*

Traditional Teak only produces handmade products which live up to high quality standards, as do our premium garden furniture covers. Made of a polyurethane coated fabric, they are breathable, high surface protection and easy to use.

**Our premium covers are :** Waterproof - UV stabilized - frost resistant - washable up to 30° C - easy foldable.

### *Und die Tradition geht weiter ...*

Alle Traditional Teak Produkte werden in Handarbeit gefertigt und erfüllen so einen hohen Qualitätsanspruch. Das Premium Produkt unter den Traditional Teak Gartenmöbel-Abdeckhauben. Hergestellt aus einem PU-beschichtetem Textilgewebe. Atmungsaktiv und besonders schonend zur Oberfläche. Speziell entwickelt für hochwertige wertvolle Gartenmöbel und sehr einfach in der Handhabung.

**Unsere premium covers sind :** wasserdicht - UV-stabilisiert - frostbeständig - waschbar bis 30°C - leicht zusammenlegbar.



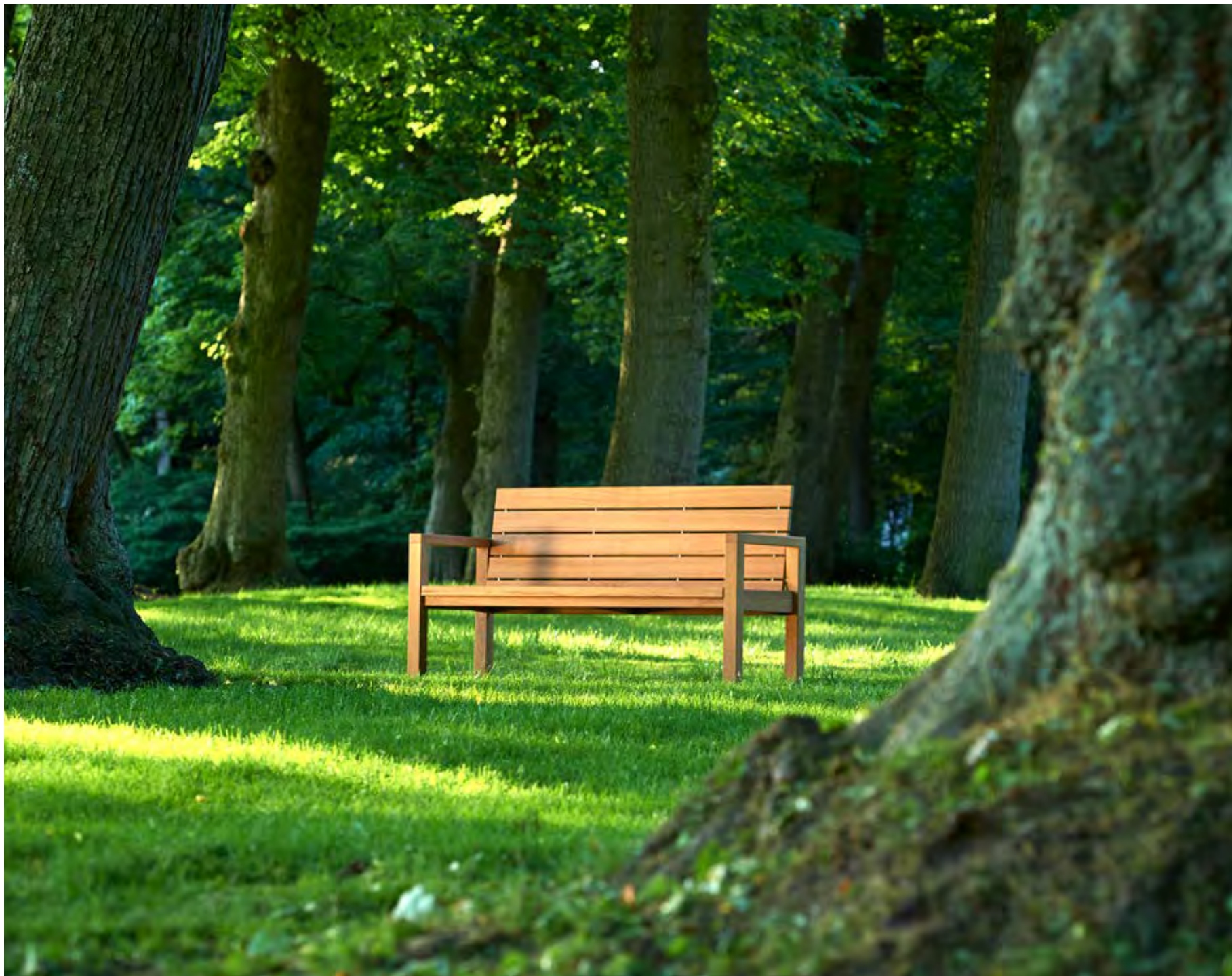



**T** Traditional  
Teak





[info@traditionalteak.nl](mailto:info@traditionalteak.nl)

[www.traditionalteak.nl](http://www.traditionalteak.nl) / [www.traditionalteak.de](http://www.traditionalteak.de) / [www.traditionalteak.com](http://www.traditionalteak.com)

We hereby would like to thank everyone who has contributed to the realisation of this catalog